

PART NO.	"A"	"B" REF.	"C" HOLDING DIA.	CABLE RECOMMENDATIONS	
				COAX	COMPUTER
SCD-1521	.30(7.6)	.25(6.4)	.156-.218(4.0-5.5)	RG58	
SCD-2228	.36(9.1)	.29(6.6)	.218-.280(4.0-7.1)	RG59,62,6	9 LINE
SCD-2838	.47(11.9)	.38(9.8)	.280-.375(7.1-9.5)	TWINAX	9-15 LINE
SCD-3844	.55(14.0)	.43(10.9)	.375-.438(9.5-11.1)		25 LINE

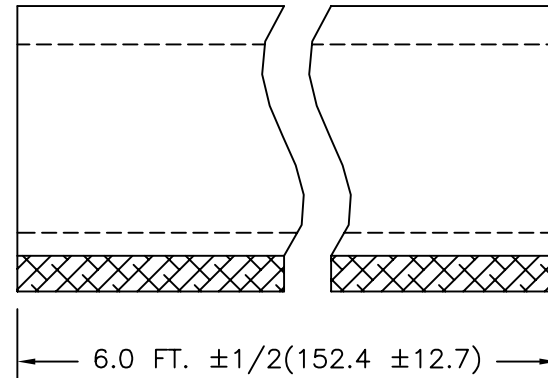
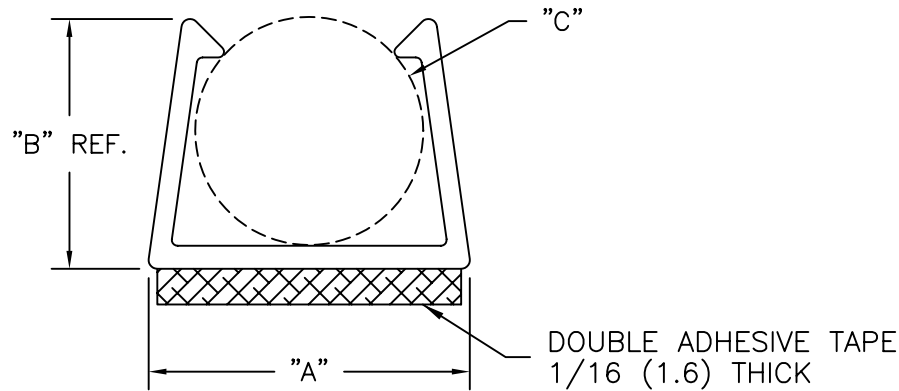
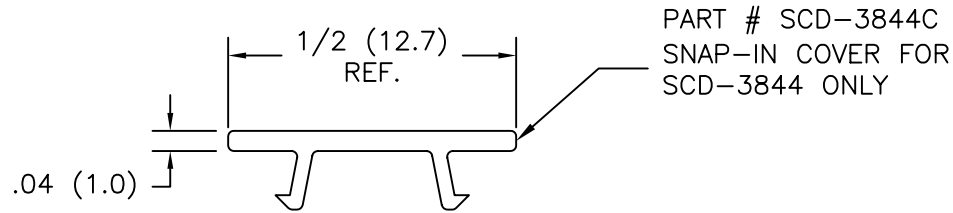

NOTES:

1. MATERIAL: RIGID PVC (RMS-32).
2. COLOR: COMPUTER TAN.
3. ACRYLIC ADHESIVE TAPE (RMS-15), WHITE LINER.
4. MAX. OPR. TEMP.: 120° F.
5. AVAILABLE IN CUSTOM CUT LENGTH UPON REQUEST.
6. PACKAGING: 10 PIECES, 6 FT. LONG.

F			TITLE: SINGLE CABLE DUCT			DWG IN INCHES		FINAL	
RMS-32 WAS RMS-04 (ECN #465)			SM 09.19.02			FILE # SCD		DWN: R.S. APP:	
ADDED RMS-04 TO MAT'L NOTE			SM 08.05.02			MAT'L: SEE NOTES		DT: 05-03-93 DT:	
ADDED NOTE 6.			SM 03.20.02			RE: RICHCO, INC.		PART #	
ADDED NOTE 3.			SM 06.29.01			RICHCO INC.		SEE TABLE	
FILE # WAS 05530			RG11/17/00			PO BOX 804238, CHICAGO, 60680		PRINT TYPE	
DIM DOUBLE ADHESIVE TAPE WAS NOTE 5			PB 102794			(773) 539-4060		CA	
DESCRIPTION			ENGR DATE			TOLERANCES UNLESS NOTED			
						.XX=±.020			
						.XXX=±.015			
						FRAC=±1/32			
						ANG=±1°			